



MT Alpha

Physiotherapy Device

15-20 minutes everyday, get a healthy life!
Musculoskeletal conditions and related
symptoms can be improved significantly from
the clinical human test*

User Manual

MAX-M01MC0552



*Clinical human test results were conducted by  MTcure in collaboration with the
Faculty of Medicine, The Chinese University of Hong Kong



COMPANY PROFILE

After two decades of experience in the health industry, **maxcare** founder utilized his knowledge and expertise in massage therapy from an Asian-Pacific perspective to establish our brand - **maxcare**. Our massage therapy business was expanded to Hong Kong in 2012 and is conferred 2017 Hong Kong Top Brand Award. Based in Hong Kong, we are specializing in design & innovation, manufacturing, and retailing of massage and healthcare products.

Believing in the value of 'Technology improves our quality of life' and 'Caring for your family', **maxcare** has been innovating highly qualified products with international patents. Besides, **maxcare** products fulfill various international safety standards, namely EU CE Mark, US UL/ETL Mark, Germany GS Mark, TUV certification, and China CCC Mark.

Motivated by our value, **maxcare** founder has been leading us to be one of the most competitive brands in Hong Kong health industry. **maxcare** applies the contemporary fashion design – neat and modern – on the mechanical engineering of massage chairs. To deliver our value and offer incredible massage experience and healthcare solution to the public, **maxcare** devotes to the innovation, design, manufacturing the top-notch family massage products. By integrating the company philosophy – Spirit Of Healthy Life - into our products, **maxcare** brings health to everyone.



MT Alpha

Physiotherapy Device

MTcure Biotech Ltd., an innovative biotechnology start-up incubated by The Chinese University of Hong Kong

 MTcure is an innovative biotechnology company that specializes in medical therapy services and products, which include household therapeutic systems and personalized clinic and beauty services. The technologies include degenerative diseases care, knee osteoarthritis treatment, rehabilitation as well as tissue repair. MTcure was founded in 2018 by a team of engineers, doctors, and professors from The Chinese University of Hong Kong (CUHK). Our objective is to bring professional medical therapy to family and community.

MT Alpha physiotherapy device

Thank you for purchasing the  collaboration with  products. Before using the product, please read this manual thoroughly, particularly the Safety Precautions section, for the correct use of the product.

This manual should be well kept for easy reference. It enables you to perform a safe and efficient operation.

CONTENT

Safety Precautions	P.01 - P.03
Product Introduction	P.04
Name and Function of Components	P.05
How to Use	P.06
Cleaning and Maintenance	P.07
FAQs and Solutions	P.08
Technical Specifications	P.09



Safety Precautions



1. Important safety warning

- Please use a well-grounding power supply suited to this product.
- Please pull out the plug after use or before cleaning to avoid injury or damage to the product.
- Do not use unauthorized accessories.
- Please read this manual instruction carefully before operation.
- Any other usages that are not listed in this manual instruction are forbidden.
- Please check if any part of this product is damaged before use. If so, please do not use it and contact us for repair.
- Please do not use it if the product is broken or damaged.
- Please do not use it if the cover or surface is damaged.
- Please do not drop anything into this product.
- Please do not allow water or liquid into this product.
- Please do not fall asleep while using this product.
- Please do not use it if drunk or feeling unwell.
- Please do not overexertion while using the product.
- Keep the plug clean from needles, rubbish, or water.
- If the power cord is damaged, do not attempt to change on your own. Please contact us for repair for safety reasons.



2. Environment for usage

- Please do not use it in a moist environment such as a bathroom.
- Please do not use it when there is a drastic change in temperature.
- Please do not use it under a heavy-dusty or caustic environment.
- Please do not use it where there is not enough space or not a good ventilation.
- Please switch off the power and unplug the machine after use.
- Please do not use it when the surrounding temperature is up to 50°C.
- Please do not use it when the surrounding temperature is below -20°C. The lubricant can thicken quickly and increase the friction between parts.
- Turn off and pull out the plug during thunderstorms.
- Do not place it near fire or directly under the sun.
- When moved from a low-temperature storage to a warm environment, the moisture inside the machine may affect, or damage, its functionality. Please rest the product within room temperature for 1 hour before use.



Safety Precautions



3. People who have the below symptoms, please consult a doctor before use

- People who are suffering from heart disease or carrying electronic medical equipment such as heart pacemaker.
- People who have cancers, acute illnesses, heart diseases, or severe high blood pressure, etc.
- People who have acute pain and cause to edema, bacterial infection, inflammation, fracture, sprain, muscle strain.
- People who have skin diseases, such as infections skin diseases, the skin is insensitive to heat and wound, etc.
- People who are receiving medical treatment, especially those who are physically unfit.
- People who a bleeding tendency.
- People who have a fever.
- Elderly with serious uncomfortable.
- Pregnant women, women who just give birth or are in the menses period.
- Children under 10-year old or people mentally unbalanced without being supervised are not allowed to use this machine.
- Stop using this product if it causes discomfort, and please consult a doctor.
- We reserve the right of the final interpretation. If the hidden dangers caused by unreasonable use, we would not take all the consequences.



4. Precautions before using the product and some safety instructions

- Do not use the deep tissue stimulation and FDA-reg heat therapy on the area that implanted metal or other materials. Also including the inflammation situation. It is suggested to use photobiomodulation and keep the massager head with 3-5mm distance to the skin surface.
- Do not use the deep tissue stimulation and FDA-reg heat therapy on the area that have wound, pimple and suppurative disease. When the wound stops bleeding or tissue is sprained, it is suggested to use photobiomodulation only with the benefit of accelerating the healing process. After 72 hours or wound has healed, it is safe to use the machine.
- Do not use the machine on heart, head, eyes, and private parts.
- Pregnant women and puerpera are not allowed to use the machine on abdominal.
- Do not directly view the light. (Included wear sunglasses or protective spectacles)
- Please do not place heavy objects on this product.
- Do not use other therapy devices while using this product.
- This product is not to be used for medical treatment purposes. Only use for improvement and relief purposes.
- Recommended usage time of this product is 15 - 20 minutes/ session.
- Check if the voltage is suitable for the specification of this product.
- Do not use wet hands to pull the plug and use the machine.



Safety Precautions

- Do not allow water to get into the product, for the avoidance of electric shock or damage to this product.
- Do not pull or drag the power cord when unplugging. Please be gentle.
- Do not damage the wires or change the circuit and alter the structure or parts of this product.
- Do not use wet cloths to clean the electric parts such as the switch and plug.
- Stop using this product if it appears any irregularity, and please contact us immediately.
- Stop using this product if it causes discomfort, and please consult a doctor.
- This appliance is not intended for people (including children) with reduced physical, sensory or mental capabilities, or a lack of experience and knowledge, unless they are under supervision or instruction concerning the use of the appliance by a person responsible for their safety.
- Children should be supervised to ensure that they do not play with the appliance.
- If the power cord is damaged, it must be replaced by us in order to avoid a hazard.
- Keep the power cord away from hot or moving objects.
- Please cut off power and pull out the plug before moving.
- If the product is found damaged, broken, suffering from power leakage, or with exposed parts, please stop using it.
- This product contains a lithium-ion rechargeable battery.
- Do not push or clamp down on the machine.
- Do not place this product near fire or where it causes fire easily to avoid accidents; the product may also deform, fade, or break.



5. Maintenance

- This product should be maintained by us, users are prohibited to disassemble or maintain by themselves.
- Please always turn off the main power after use.
- Do not use this product if the socket is loose.
- If this product is to be left idle for long, please tie up the power cords and keep it in a dry and dustless environment.
- Do not keep this product at a high temperature or near a fire. Do not keep under direct sunlight.
- Please clean this product with dry cloths. Do not use thinner, benzene, or alcohol.
- Please use wet cloths to clean the massage head after you use the machine.
- The mechanical components of this product are specially designed and made, no special maintenance required.
- Do not point sharp objects at this product.
- Please use it intermittently; do not keep it continuously running for long.
- This product contains an irreplaceable battery.



6. Solution of ordinary malfunctions

- It is normal if the motor makes noises during operation.



Product Introduction

Product Features:

MT Alpha is an innovative rehabilitation device jointly researched and developed by MTcure and the Faculty of Medicine, The Chinese University of Hong Kong. And Maxcare provides engineering and manufacturing supports. The core rehabilitation system bases on Bio-Medical Combination of Treatment technology which can provide three rehabilitation signals: Deep-Tissue Stimulation, Photobiomodulation, and FDA-reg Heat Therapy. The stimulation signals and energy are designed according to rehabilitation standards with FDA's approval.

Musculoskeletal conditions and related degenerative symptoms can be improved significantly from the clinical human test

Product Function:

Deep tissue stimulation	Excitation can stimulate the deep tissue in order to relieve pain, promote blood and lymphatic circulation, and improve the musculoskeletal condition.
Photobiomodulation	Excitation can activate tissue regeneration, relieve pain, and alleviate the inflammation, the signal is a kind of laser designed with two medical-use wavelengths and the energy level is established according to the medical standard.
FDA-reg heat therapy	FDA-reg heat therapy can relieve pain and accelerate blood circulation.

Effectively relieve the following symptoms *



Sports injury
(Recommend to use after 24-36 hours)



Muscle strain



Arthritis/
Degenerative Diseases

**Clinical human test results were conducted by  MTcure in collaboration with the Faculty of Medicine, The Chinese University of Hong Kong.

 Name and Function of Components

Massager



USB Charger

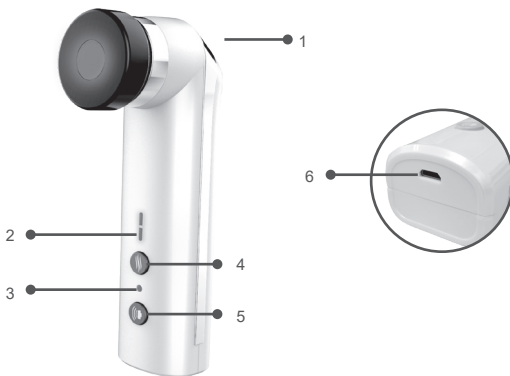

1. Massage head: Deep tissue stimulation, FDA-reg heat therapy, photobiomodulation
2. Heat level Indicator light: 1 light means level 1, 2 lights mean level 2
3. Charging Indicator light: Red light is charging, Blue light is fully charged.
4. FDA-reg heat therapy and photobiomodulation
5. Deep tissue stimulation and photobiomodulation
6. USB charging port







How to Use

Before you use:

- Suggested to use 15-20 minutes and 1-2 times every day.
- Suggested to do some stretching exercises before you use the machine, can effectively relieve pain.
- Suggested to consult the doctor that the painful part is it suitable to use this product.

How to use

1. Please fully charge before you use it. (Unplug the power before use, otherwise it won't open)
2. Massage head is faced down, and presses the button H  around 2-3 seconds, and then presses button D  around 2-3 seconds.
3. Press on the painful area gently and horizontally. Gently circle around it and cannot stay at the same point for a long time.
4. Treatment level
Button H  : After switch on, the middle mode is default setting, press it to become high mode.
Button D  : After switch on, the middle mode is default setting, press it to become high mode.
press it again to become light mode.
5. It is recommended to apply the medical ointment after the use of MT Alpha, so that the medicine can be absorbed more effectively with the help of warm effect.
6. Please wipe the massage head with a cloth dampened water or alcohol after use.

Remarks :

- When the power is about to run out, the charging indicator will flash to remind the user to charge.
- It is recommended to switch off the machine after more than 20 minutes of continuous use to cool down it, so that service life can be prolonged.
- The massage head is advised to be used in direct contact with skin surface. Healing effect could greatly diminish if used through clothing.
- When the massage head is pressed too hard on the skin, it will automatically stop vibrating to prevent muscle damage.



 **Cleaning and Maintenance****Cleaning**

- Before cleaning, please make sure the switch has been turned off, and the power plug has been pulled out from the socket.
- Please use a piece of clean and soft cotton cloth to clean this product. The cloth can be soaked in soap water first, but please dry it to damp before cleaning.

**CAUTION**

- Do not pull the plug from the socket with wet hands.
- Rinsing this product with water is not allowed.
- Do not use corrosive cleaning agents like benzene or thinner to clean the product, otherwise, the color of the product will fade, and the internal parts may be corrupted or broken.
- Do not disassemble the product when it is wet.
- When not in use, turn off the main power, and remove the plug from the socket.
- Keep the product clean and away from high-temperature/ humid areas, or any environment with volatile gases.

Maintenance

- Make sure that the plug has been disconnected from the socket before maintenance.
- Keep the product clean and away from high-temperature/ humid areas, or any environment with volatile gases.
- If this product is to be left idle for long, properly cover it with a dust cover (self-purchase).

**CAUTION**

- Please keep the product away from direct sunlight, or high temperature, to avoid fading or product damage.

Gentle reminder

- If the product is used through the year, please check conditions as below:
 - * Burnt smell.
 - * Unstable power supply after contact with the power cord.
 - * Power cord heating up.
 - * Power cords damage.
 - * Other abnormalities.

**CAUTION**

- If above mentioned happens, please stop using the product.
- Switch off the power supply, pull out the plug, and contact us.
- Don't disassemble the product by yourself.



FAQs and Solutions

Issues	Possible Causes	Solutions
Already press the power button but still not working.	Out of battery	Please fully charge before you use it.
	Running down of battery	Please contact us
	Did not press the button about 2-3 seconds	Please press the button about 2-3 seconds
Suddenly shut down when you using	Out of battery	Please fully charge before you use it.
	Press too much pressure on the skin	Please restart and gently place it on your skin
Can only use few minutes when fully charged	Running down of battery	Please contact us to replace the battery
The indicated light not working when you charging	The USB charging cable did not connect to the correct charging port	Please connect to the correct charging port
	Wire or plug not properly connected	Please reconnect
Speed is slow and not powerful	Out of battery	Please fully charge before you use it.
Skin turning red and painful	Usage time too long	Suggested to use about 15-20 minutes
	The skin is sensitive to heat and the materials of the massage head	Please check the allergic history and consult with the doctor whether is it suitable to use this machine.
Skin abnormally heat	Massage head stay in one area for too long	Gently circle around it and cannot stay at the same point for a long time.
Muscle abnormally feeling painful	Vibration level too strong	Turn down the vibration level
Eyes feeling painful	Massage head with a red light was directly facing to the eyes	Avoid the massage head with red lights facing the eyes
The "deep tissue stimulation" button is pressed and the massage head does not vibrate.	The massage head is being jammed and cannot vibrate due to low battery	Please fully charge before you use it
		Gently press the massage head with your hand

If there are abnormally happened after the above solutions, please contact us.



Technical Specifications

Product Name	: MT Alpha Physiotherapy Device
Product Model	: MAX-M01MC0552
Treatment stimulation	: Deep tissue stimulation Photobiomodulation FDA-reg heat therapy
Rated Power	: 5.5-6.5W
Battery Capacity	: 3.7V/ 2600mAh
Charging Time	: 2.8 hours
Automatic Shutdown Time	: 10 minutes
Product Size	: 16x4x6.8cm
Net Weight	: 195g

美斯凱實業有限公司

MAXCARE INDUSTRIAL LIMITED

客戶服務熱線 Customer Service Hotline : (852) 2950-9383

www.maxcare.net

www.maxcareonlineshop.com

Maxcare united MTcure, an innovative biotechnology start-up incubated by
The Chinese University of Hong Kong

鎂天健康生物科技有限公司

MTCURE BIOTECH LIMITED